

XG

Snap-action Microswitches

Miniature

XG

- Characteristics
- Wide number of force variants
 - High mechanical and electrical life
 - Solder terminals
 - Quick connect
 - PCB terminals
 - High temperature versions
 - Wide range of levers

Rating 250 VAC, 26 A

Dimensions (mm) 27.8 × 15.9 × 10.3

Actuator Plunger, plain levers, roller levers, simulated (cam follower) roller lever

Approvals UL, cUL, CSA, ENEC

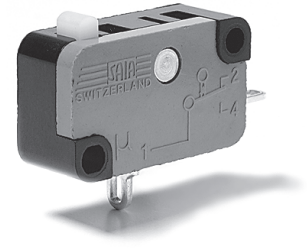

Preferred Range

Ordering Reference	Actuating Force (N)	Actuating Force (ozf)	Operating pos. (mm)	Operating pos. (in)	Terminal	Circuit	Actuator	Contacts	Electrical rating ENEC	UL/CSA
XGG2-88Z1	3.20	11.43	14.7	0.57	Faston	CO	Plunger	Ag / AgNi10	16(6) A	15 A
XGG2-88-J23Z1	1.40	5.03	14.9	0.59	Faston	CO	Plain lever	Ag / AgNi10	16(6) A	15 A
XGG2-88-J26Z1	0.91	3.27	14.5	0.57	Faston	CO	Plain lever	Ag / AgNi10	16(6) A	15 A
XGG2-88-J27Z1	0.65	2.34	13.7	0.54	Faston	CO	Plain lever	Ag / AgNi10	16(6) A	15 A
XGG2-88-S20Z1	3.20	11.43	20.2	0.79	Faston	CO	Roller lever	Ag / AgNi10	16(6) A	15 A
XGG2-88-S21Z1	1.55	5.57	20.1	0.79	Faston	CO	Roller lever	Ag / AgNi10	16(6) A	15 A
XGG3-88Z1	3.20	11.43	14.7	0.57	Solder	CO	Plunger	Ag / AgNi10	16(6) A	15 A
XGG6-88Z1	3.20	11.43	14.7	0.57	Faston	CO	Plunger	Ag / AgNi10	16(6) A	15 A
XGC2-88Z1	0.80	2.86	14.7	0.57	Faston	CO	Plunger	Ag / AgNi10	12(6) A	10 A
XGC2-88-J23Z1	0.35	1.26	15.0	0.59	Faston	CO	Plain lever	Ag / AgNi10	12(6) A	10 A
XGC2-88-S20Z1	0.80	2.86	20.2	0.79	Faston	CO	Roller lever	Ag / AgNi10	12(6) A	10 A
XGC6-88Z1	0.80	2.86	14.7	0.57	Faston	CO	Plunger	Ag / AgNi10	12(6) A	10 A
XGK2-88Z1	1.50	5.36	14.7	0.57	Faston	CO	Plunger	Ag / AgNi10	12(6) A	12 A
XGK2-88-J26Z1	0.43	1.55	14.7	0.57	Faston	CO	Plain lever	Ag / AgNi10	12(6) A	12 A
XGK2-88-S21Z1	0.71	2.55	20.2	0.80	Faston	CO	Roller lever	Ag / AgNi10	12(6) A	12 A
XGK3-88Z1	1.50	5.36	14.7	0.57	Solder	CO	Plunger	Ag / AgNi10	12(6) A	12 A
XGK6-88Z1	1.50	5.36	14.7	0.57	Faston	CO	Plunger	Ag / AgNi10	12(6) A	12 A
XG02-88Z1	1.20	4.29	14.5	0.57	Faston	CO	Plunger	Ag / AgNi10	16(6) A	15 A
XG02-88-J27Z1	0.25	0.90	13.6	0.54	Faston	CO	Plain lever	Ag / AgNi10	16(6) A	15 A
XG02-88-S20Z1	1.20	4.29	20.1	0.79	Faston	CO	Roller lever	Ag / AgNi10	16(6) A	15 A
XG06-88Z1	1.20	4.29	14.5	0.57	Faston	CO	Plunger	Ag / AgNi10	16(6) A	15 A

Specifications

Housing	Phenolic-Melamine, thermosetting
Plunger	POM for T85, PBT for T125, PPS for T150
Mechanism	Heat-treated spring made from beryllium bronze, 4 parallel current path, high contact pressure
Functions	Change-over, normally-closed (except XGG and XGK) or normally-open
Contacts	Fine silver (Ag), silver nickel (AgNi10), gold-plated 4 μm (Au), silver cadmium oxide (AgCdO)
Terminals	Solder faston, screw, PCB and side mounting PCB terminals. RAST 5 terminals, 5.0 mm pitch
Temperature range °C	-40° C to +150° C
Mechanical life	2.5 · 10 ⁵ cycles minimum, 50 · 10 ⁶ cycles maximum (Actuation: sinusoidal and maximum up to 80% of the overtravel)
Protection	Enclosure IP40
Mounting	Side mounting via mounting holes
Actuators	Stainless steel

Circuit diagram

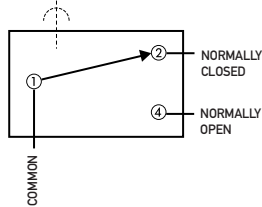

Dimensions

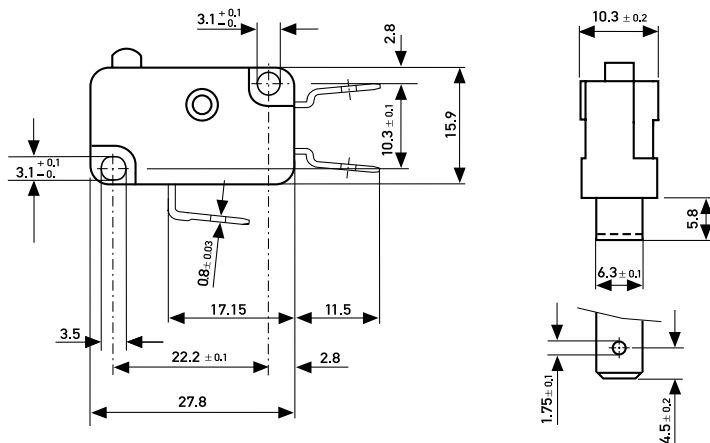

Recommended maximum electrical ratings

Voltage (VAC)	Approvals ENEC	UL	(VAC)	Voltage (VAC)	Approvals ENEC	UL	(VAC)
XGG..-88	250	16 (6) 5E4	15 A	125/250	XGT..-86	250	26 (10) 25E3 25A
XGA..-88	250	16 (6) 5E4	15 A	125/250	XGD..-86	250	22 (6) 5E4 21A
XGM..-88	250	16 (6) 5E4	15 A	125/250	XGA..-86	250	20 (8) 5E4 15A
XGO..-88	250	16 (6) 5E4	15 A	125/250	XGM..-86	250	20 (8) 5E4 15A
XGB..-88	250	12 (6) 5E4	12 A	125/250	XGO..-86	250	20 (8) 5E4 15A
XGC..-88	250	12 (6) 5E4	10 A	125/250	XGA..-86	400	10 (6) 5E4 -
XGH..-88	250	12 (6) 5E4	10 A	125/250	XGG..-86	400	10 (6) 5E4 -
XGK..-88	250	12 (6) 5E4	12 A	125/250	XGM..-86	400	10 (6) 5E4 -
XG....-88	400	3 (2) 5E4			XGO..-86	400	10 (6) 5E4 -

Operating Characteristics

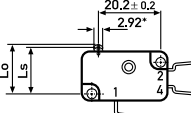
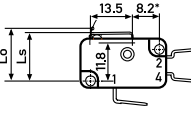
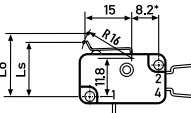
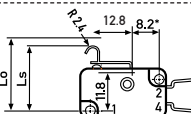
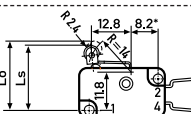
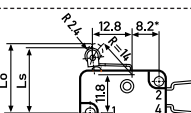
Actuator	Reference	Actuating Force		Release Force		Free Position		Operating Position		Movement Differential		Total travelled position		
		Maximum (N)	(ozf)	Minimum (N)	(ozf)	Maximum (mm)	(in)	(mm)	(in)	Maximum (mm)	(in)	(mm)	(in)	
	XGG..	3.2	11.43	0.4	1.43	15.75	0.62	14.7	$\left. \begin{matrix} 0.57 \\ 0.57 \\ 0.57 \\ 0.57 \\ 0.57 \\ 0.57 \\ 0.57 \\ 0.57 \\ 0.57 \end{matrix} \right\} \begin{matrix} +0.2 \\ -0.4 \end{matrix}$	$\left. \begin{matrix} 0.57 \\ 0.57 \\ 0.57 \\ 0.57 \\ 0.57 \\ 0.57 \\ 0.57 \\ 0.57 \\ 0.57 \end{matrix} \right\} \begin{matrix} +0.007 \\ -0.015 \end{matrix}$	0.35	0.013	13.2	0.519
	XGA..	3.2	11.43	0.6	2.14	15.75	0.62	14.7			0.15	0.006	13.2	0.519
	XGM..	2	7.14	0.5	1.79	15.6	0.61	14.5			0.35	0.013	13.7	0.539
	XGO..	1.2	4.29	0.1	0.36	15.6	0.61	14.5			0.35	0.013	13.7	0.539
	XGK..	1.5	5.36	0.2	0.71	15.75	0.62	14.7			0.35	0.013	13.2	0.519
	XGB..	1.5	5.36	0.3	1.07	15.75	0.62	14.7			0.15	0.006	13.2	0.519
	XGC..	0.8	2.86	0.1	0.36	15.75	0.62	14.7			0.15	0.006	13.2	0.519
	XGH..	0.45	1.61	0.05	0.18	15.6	0.61	14.5			0.35	0.013	13.7	0.539
	XGD..	1.7	6.07	0.15	0.54	15.75	0.62	14.7			0.15	0.006	13.2	0.519
	XGG..	3.2	11.43	0.36	1.29	16.5	0.64	15.1 ± 0.5	0.59 ± 0.019	0.4	0.015	14	0.551	
	XGA..	3.2	11.43	0.54	1.93	16.5	0.64	15.1 ± 0.5	0.59 ± 0.019	0.2	0.007	14	0.551	
	XGM..	2	7.14	0.45	1.61	16.5	0.64	15 ± 0.5	0.59 ± 0.019	0.4	0.015	14.4	0.566	
	XGO..	1.2	4.29	0.09	0.34	16.5	0.64	15 ± 0.5	0.59 ± 0.019	0.4	0.015	14.4	0.566	
	XGK..	1.5	5.36	0.18	0.64	16.5	0.64	15.1 ± 0.5	0.59 ± 0.019	0.4	0.015	14	0.551	
	XGB..	1.5	5.36	0.27	0.96	16.5	0.64	15.1 ± 0.5	0.59 ± 0.019	0.2	0.007	14	0.551	
	XGC..	0.8	2.86	0.09	0.32	16.5	0.64	15.1 ± 0.5	0.59 ± 0.019	0.2	0.007	14	0.551	
	XGH..	0.45	1.61	0.04	0.14	16.5	0.64	15 ± 0.5	0.59 ± 0.019	0.4	0.015	14.4	0.566	
	Width of lever 7 mm/0.28 in													
	XGG..	2.6	9.29	0.32	1.14	19.2	0.75	17.5 ± 0.7	0.68 ± 0.027	0.45	0.017	16.4	0.645	
	XGA..	2.6	9.29	0.48	1.71	19.2	0.75	17.5 ± 0.7	0.68 ± 0.027	0.2	0.007	16.4	0.645	
	XGM..	1.65	5.89	0.4	1.43	19.2	0.75	17.3 ± 0.7	0.68 ± 0.027	0.45	0.017	16.9	0.665	
	XGO..	1	3.57	0.08	0.29	19.2	0.75	17.3 ± 0.7	0.68 ± 0.027	0.45	0.017	16.9	0.665	
	XGK..	1.25	4.46	0.16	0.57	19.2	0.75	17.5 ± 0.7	0.68 ± 0.027	0.45	0.017	16.4	0.645	
	XGB..	1.25	4.46	0.24	0.86	19.2	0.75	17.5 ± 0.7	0.68 ± 0.027	0.2	0.007	16.4	0.645	
	XGC..	0.65	2.32	0.08	1.29	19.2	0.75	17.5 ± 0.7	0.68 ± 0.027	0.2	0.007	16.4	0.645	
	XGH..	1.37	1.32	0.04	0.14	19.2	0.75	17.3 ± 0.7	0.68 ± 0.027	0.45	0.017	16.9	0.665	
	Width of lever 7 mm/0.28 in													
	XGG..	3.2	11.43	0.38	1.36	21.8	0.85	20.5 ± 0.6	0.81 ± 0.023	0.4	0.015	19.5	0.767	
	XGA..	3.2	11.43	0.85	3.04	21.8	0.85	20.5 ± 0.6	0.81 ± 0.023	0.2	0.007	19.5	0.767	
	XGM..	2	7.14	0.48	1.71	21.8	0.85	20.3 ± 0.6	0.8 ± 0.023	0.4	0.015	19.8	0.779	
	XGO..	1.2	4.29	0.09	0.32	21.8	0.85	20.1 ± 0.6	0.79 ± 0.023	0.4	0.015	19.8	0.779	
	XGK..	1.5	5.36	0.19	0.68	21.8	0.85	20.5 ± 0.6	0.81 ± 0.023	0.4	0.015	19.5	0.767	
	XGB..	1.5	5.36	0.29	1.04	21.8	0.85	20.5 ± 0.6	0.81 ± 0.023	0.2	0.007	19.5	0.767	
	XGC..	0.8	2.86	0.09	0.32	21.8	0.85	20.5 ± 0.6	0.81 ± 0.023	0.2	0.007	19.5	0.767	
	XGH..	0.45	1.61	0.04	0.14	21.8	0.85	20.3 ± 0.6	0.8 ± 0.023	0.4	0.015	19.8	0.779	
	Width of lever 7 mm/0.28 in													
	XGG..	3.2	11.43	0.37	1.32	21.8	0.85	20.2 ± 0.7	0.79 ± 0.027	0.4	0.015	19.3	0.759	
	XGA..	3.2	11.43	0.56	2	21.8	0.85	20.2 ± 0.7	0.79 ± 0.027	0.2	0.007	19.3	0.759	
	XGM..	2	7.14	0.47	1.68	21.8	0.85	20.1 ± 0.7	0.79 ± 0.027	0.4	0.015	19.7	0.775	
	XGO..	1.2	4.29	0.09	0.32	21.8	0.85	20.1 ± 0.7	0.79 ± 0.027	0.4	0.015	19.7	0.775	
	XGK..	1.5	5.36	0.18	0.64	21.8	0.85	20.2 ± 0.7	0.79 ± 0.027	0.4	0.015	19.3	0.759	
	XGB..	1.5	5.36	0.28	1	21.8	0.85	20.2 ± 0.7	0.79 ± 0.027	0.2	0.007	19.3	0.759	
	XGC..	0.8	2.86	0.09	0.32	21.8	0.85	20.2 ± 0.7	0.79 ± 0.027	0.2	0.007	19.3	0.759	
	XGH..	0.45	1.61	0.04	0.14	21.8	0.85	20.1 ± 0.7	0.79 ± 0.027	0.4	0.015	19.7	0.775	
	Width of roller 6.6 mm/0.26 in													
	XGG..	3.2	11.43	0.37	1.32	21.8	0.85	20.2 ± 0.7	0.79 ± 0.027	0.4	0.015	19.3	0.759	
	XGA..	3.2	11.43	0.56	2	21.8	0.85	20.2 ± 0.7	0.79 ± 0.027	0.2	0.007	19.3	0.759	
	XGM..	2	7.14	0.05	1.68	21.8	0.85	20.1 ± 0.7	0.79 ± 0.027	0.4	0.015	19.7	0.775	
	XGO..	1.2	4.29	0.09	0.32	21.8	0.85	20.1 ± 0.7	0.79 ± 0.027	0.4	0.015	19.7	0.775	
	XGK..	1.5	5.36	0.18	0.64	21.8	0.85	20.2 ± 0.7	0.79 ± 0.027	0.4	0.015	19.3	0.759	
	XGB..	1.5	5.36	0.28	1	21.8	0.85	20.2 ± 0.7	0.79 ± 0.027	0.2	0.007	19.3	0.759	
	XGC..	0.8	2.86	0.09	0.32	21.8	0.85	20.2 ± 0.7	0.79 ± 0.027	0.2	0.007	19.3	0.759	
	XGH..	0.45	1.61	0.04	0.14	21.8	0.85	20.1 ± 0.7	0.79 ± 0.027	0.4	0.015	19.7	0.775	
	Width of roller 6.6 mm/0.26 in													

¹⁾ Lever distance 8.2 (0.32) for lever position -20, lever position (-J20, L20, S20, M20)
Lever distance 14.0 (0.55) for lever position -40, lever position (-J40, L40, S40, M40)

* For high temperature T125°C/T 150°C (ENEC, UL)

Ordering Reference

Type	XGG..	3.2 N	11.43 ozf
Actuating	XGA../XGT..	3.2 N	11.43 ozf
Characteristic	XGM..	2.0 N	7.14 ozf
	XGO..	1.2 N	4.29 ozf
	XGK..	1.5 N	5.36 ozf
	XGB..	1.5 N	5.36 ozf
	XGC..	0.8 N	2.86 ozf
	XGH..	0.45 N	1.61 ozf
	XGD..	1.7 N	6.07 ozf

Circuit	No digit	Change-over
	4	Normally closed (NC)
	5	Normally open (NO)

Terminals	02	Faston	6.3 × 0.8
	03	Solder	1.7 × 3.2
	06	Faston	4.8 × 0.5
	10	Faston	4.8 × 0.8
	12	Short solder	Ø 2.3
	15	RAST 5	6.3 × 0.8

Other types of terminals are available on request

Version	No digit	ENEC	UL	Number of operations at rated load	
				Europe	UL
	A	T85	T90	50.000	6.000
	W	T150	T150	50.000	6.000
	AW	T150	T150	50.000	100.000
	B	T85	T90	10.000	6.000
	V	T125	T130	50.000	6.000
	AV	T125	T130	50.000	100.000
	C	T85	T90	25.000	6.000

Contacts	-88	Ag / AgNi10
	-81	Gold-plated 4 µm (Au) on Ag
	-86	Ag / Ag CdO

Actuators	No digit	Plunger	
	J20/J40	Plain lever	13.5 mm
	J22/J42	Plain lever	24.0 mm
	J23/J43	Plain lever	27.8 mm
	J27/J47	Plain lever	60.0 mm
	M20/M40	Plain lever formed	14.7 mm
	L20/L40	Cam follower	12.8 mm
	L21/L41	Cam follower	26.2 mm
	S20/S40	Roller lever	12.8 mm
	T20/T40	Roller lever, 150° C version	12.8 mm

Other actuators available on request